

---

## Application Notes - Discharge Circuits

---

### Discharge Sequence

Flashtubes are connected with two different circuits:

1. The trigger circuits: operated in the trigger phase.
2. The main discharge circuits: operated in the main discharge phase.

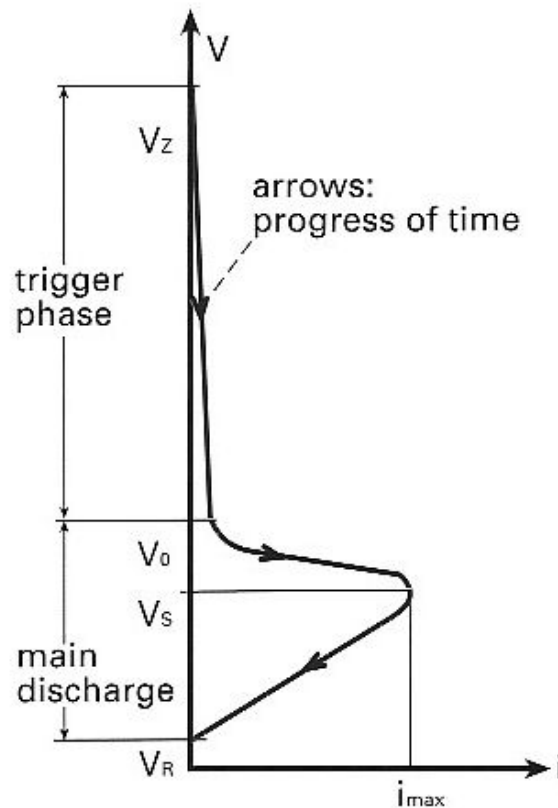

The impedance characteristic (anode voltage  $V$  versus discharge current  $i$ ) features the same form for all flash discharges. Its slope represents the characteristic of the discharge (increasing/decreasing).

First the trigger voltage  $V_z$  (2-20kV) causes ionization in the tube. This ionization alone is not sufficient for discharge. That is why the operating voltage  $V_0$  of the main discharge circuit must be reached before the triggering can be performed (decreasing characteristic). This requires energy (1-100mJ) and time (trigger delay 1-10  $\mu$ s).

The main discharge can be subdivided into the current rise (1-10 s, slightly falling characteristic) and the current decay (up to 10 $\mu$ s, increasing characteristic).

During the decay phase under normal conditions most of the light output is generated. The following internal impedance  $R_i$  of the tube can be defined:

$$R_i = \frac{V_s}{i_{\max}} \quad (0.1 \text{ to } 5 \text{ Ohms})$$

Finally, the discharge extinguishes at a residual voltage of  $V_R$  (10 to 80V).

### Main Discharge Circuits

#### 1. Free Capacitor Discharge

The energy  $E$  stored in a flash capacitor  $C_B$  (voltage  $V_0$ ) is defined as

$$\text{flash energy } E = \frac{1}{2} C_B V_0^2$$

$E$ [Ws]
$V_0$ [V]
$C_B$ [F]

neglecting a low percentage of residual energy in  $C_B$ .

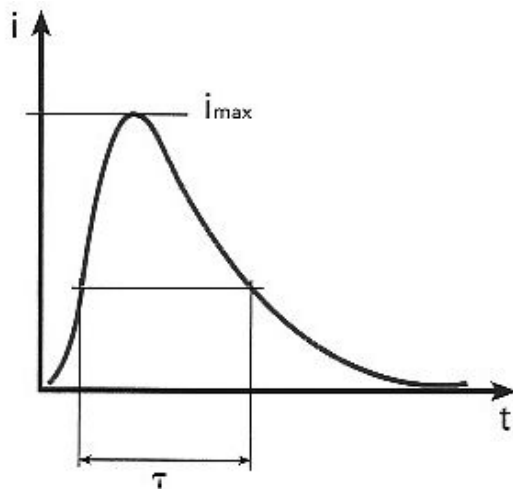

Free capacitor discharge

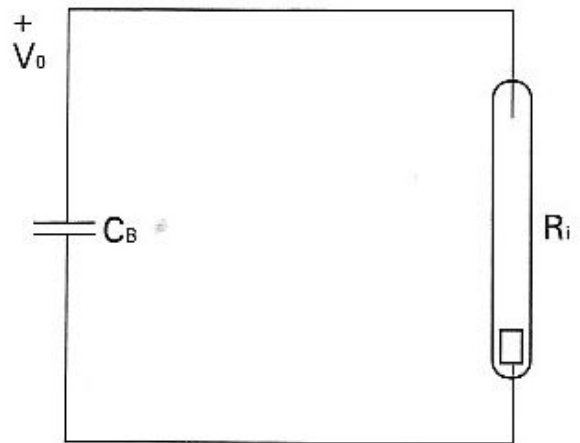

After peak current  $i_{\max}$  has been reached, an almost exponential discharge of CB takes place, since the internal resistance  $R_i$  of the tube remains constant. The time constant  $T=R_i C_B$  is a measure for the flash duration ( $\sim 1/3$  value).  $V_0$  ranges often between 200-400V. This is due to the electric strength of the electrolytic photoflash capacitors.

In stroboscopic applications, the tube's medium power load  $P$  results from the energy  $E$  of the individual pulse and the repetition rate  $f$ :

$$P = E \times f$$

$P$ [W]
$E$ [Ws]
$f$ [Hz]

## 2. Voltage Doubler

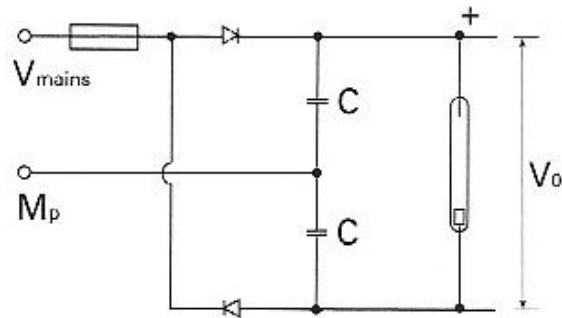

*Voltage doubler*

A variation of the free capacitor discharge is the voltage doubler, which is often directly connected to the a.c. mains

with  $V_0 = 2 \sqrt{2} V_{\text{mains}}$

flash energy  $E = 2 C V_{\text{mains}}^2$

### 3. Pulse forming network

The circuit illustrated below shows the simplest network.  $L$ ,  $C_B$  forms a resonant circuit, which is damped by the tube.

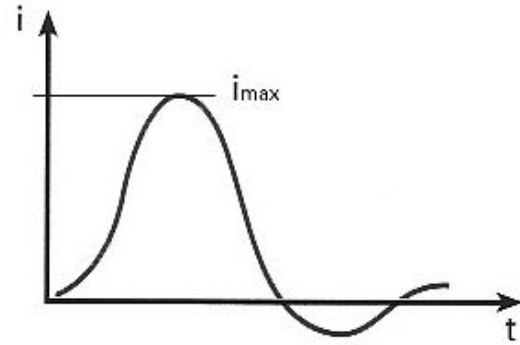
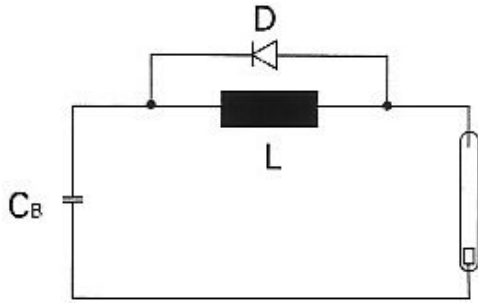

*Single LC link*

The reversal of current can be suppressed by a diode  $D$ . In comparison to the free capacitor discharge, the current rise and peak current  $i_{max}$  are reduced.

By using multiple LC links, an almost rectangular discharge pulse can be obtained.

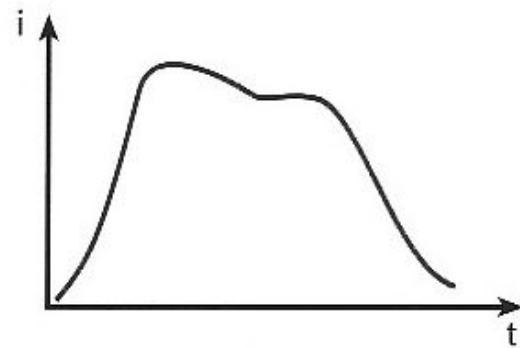
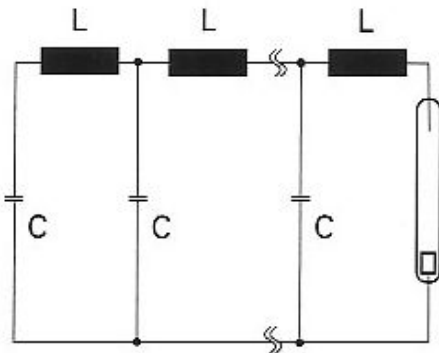

*Multiple L, C links*

## Discharge control by semiconductor

### 1. Double Thyristor (SCR)

The typical circuit for on/off switching a flashtube works with a pair of SCRs.

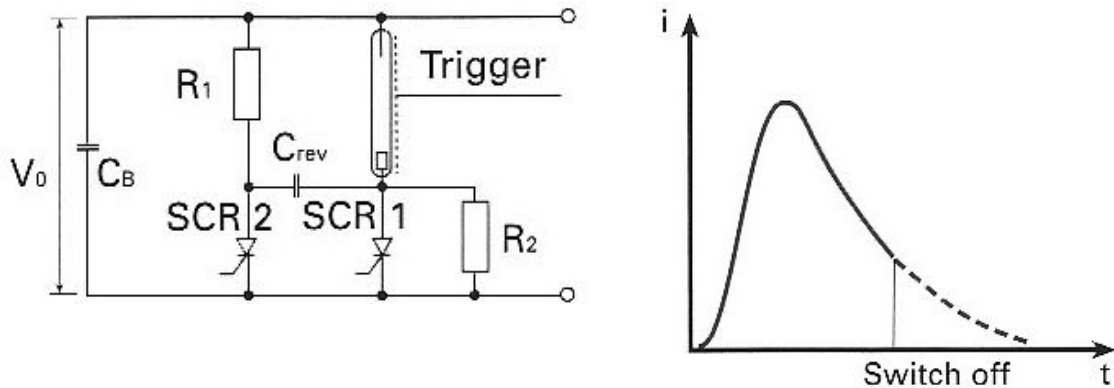

*Double thyristor discharge control*

Switching on is done by synchronizing the lamp trigger and the gate of SCR1. For switching off, SCR2 is fired, discharging  $C_{rev}$  and reversing SCR1. This circuit is sensitive for the values of  $R_1$ ,  $R_2$ ,  $C_{rev}$  and the retaining current of the SCRs. The repetition rate is limited by recharging  $C_{rev}$ .

### 2. Power Mos-Fet or IGBT

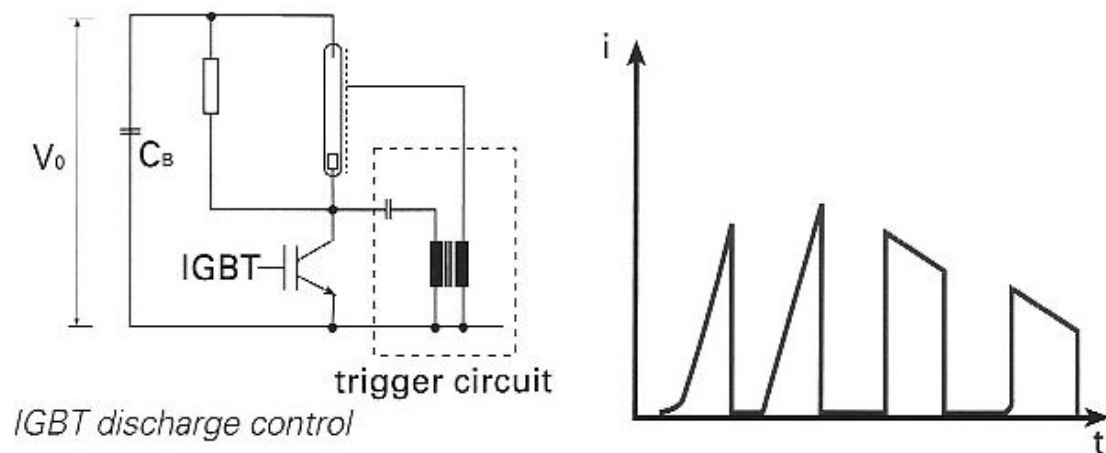

*IGBT discharge control*

The IGBT offers high peak current, high frequency switching with very low loss and simple driving circuit. This concept is ideal for discharge control of flashtubes. The IGBT also operates the tube's trigger circuit. All pulse patterns,

preflash and manipulation of the main flash are possible. Excelitas Technologies has developed special "high-impedance" flashtubes for photographic application.

### 3. Simmer Operation

The constant current source  $S$  maintains a "simmer" current  $i_s$  in the tube. When the semiconductor  $T$  is operated, any pulse-discharge pattern can be superimposed to  $i_s$ . The simmer current should be as small as possible.

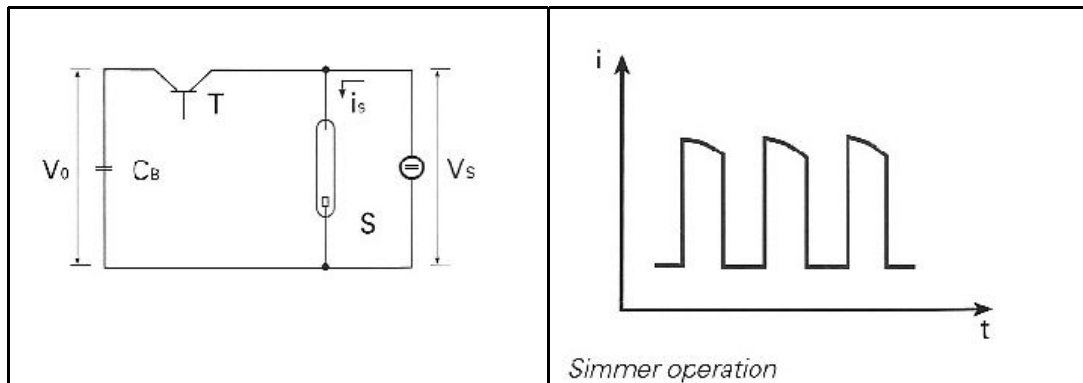

---

## Application Notes - Light of High Intensity

---

### Discharge Tube Characteristics

Apart from the glass material and electrodes, flashtubes feature three key characteristics:

1. The arc length,  $e$
2. The inner tube diameter,  $r$
3. The Xenon (Krypton) fill pressure,  $p$ .

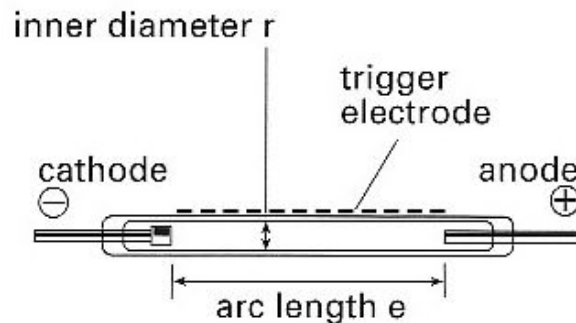

*Schematic drawing of a flashtube*

By determining  $e$ ,  $r$  and  $p$ , all conditions and requirements such as flash energy, expected life, trigger quality, size, optical projection, and spectral distribution of the light must be fulfilled. Flashtubes can be easily classified by the ratio  $e : r$ .

Tubes characterized by  $e : r < 5$  are called electrode stabilized tubes and are used in short pulses and high luminance applications. For many short-arc lamps,  $e : r < 1$  applies.

Tubes characterized by  $e : r > 5$  are called wall stabilized tubes. Most of the flashtubes are designed for  $5 < e : r < 10$ , as the best light efficiency can be obtained in this range.

The ratio  $10 < e : r < 20$  characterizes tubes with high internal impedance and long discharge duration.

Tubes with  $e : r > 20$  are seldom used.

The luminance efficiency is rising with increasing Xenon fill pressure, whereas the triggerability decreases inversely. For flashtubes that are wall-stabilized, discharge applies as follows:

$$5000 < p \cdot e < 15000 \frac{P [\text{Torr}]}{e [\text{mm}]}$$

For  $p \cdot e < 5000$ , the light efficiency decreases to a great extent. For  $p \cdot e > 15000$ , the triggerability may be a problem.



---

## Application Notes - Generation of Light by Xenon Discharge

---

Within the group of gas discharge lamps, flashtubes belong to the high-pressure arc lamps. Xenon fill pressures of 50 to 1,00 torr and current densities between 1,00 and 10,000 A/cm<sup>2</sup> provide all characteristics of an arc discharge:

- Thermalized plasma 7,000 to 10,000K, i.e. electrons, ions and atoms are in thermal equilibrium.
- The continuum radiation of Xenon is very similar to sunlight.
- Among the inert gases Xenon has the highest photometric radiation efficiency of approximately 40lm/W (i.e. at least twice the efficiency of an incandescent lamp, but half of a fluorescent tube).
- Xenon flashtubes have the highest luminance of all light sources, apart from lasers.

In flashtubes, the Xenon spectrum consists of a continuum, the distribution of which is corresponding to the radiation of a black body and a few broadened lines, which mainly occur in the infrared range (880 to 1,000nm).

The density of the discharge current mainly influences the relation between lines and continuum. By determining this current density, the portions of UV and IR radiation added to the visible light can be selected. It is not possible to emit "colored light" only. This applies for other inert gases as well.

Current densities in the range of several 100 A/cm<sup>2</sup> can only be achieved in tubes with high internal impedance. In this case the portion of IR radiation is strongly predominant. Flashtubes for Nd-Yag-laser excitation and IR technology also belong to this group.

Current densities of 1,000-3,000 A/cm<sup>2</sup>, which are applied in most studio, beacon and stroboscopic flashtubes, feature IR

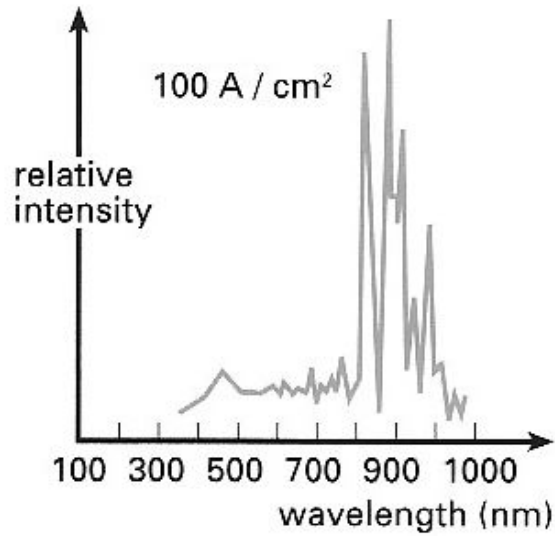

#### **Spectrum of high impedance flashtube**

as well as a strong continuum. UV radiation can also be considerable.

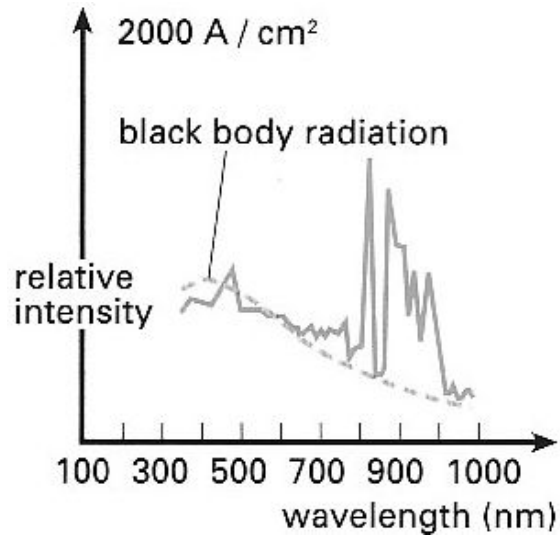

#### **Spectrum of a studio flashtube**

Current densities between 4,000 - 10,000 A/cm<sup>2</sup> feature hardly any IR lines and the continuum is now very similar to sunlight (7,000K). These tubes provide the highest visual radiation efficiency (up to 40 lm/W), especially in all photo-flashtubes.

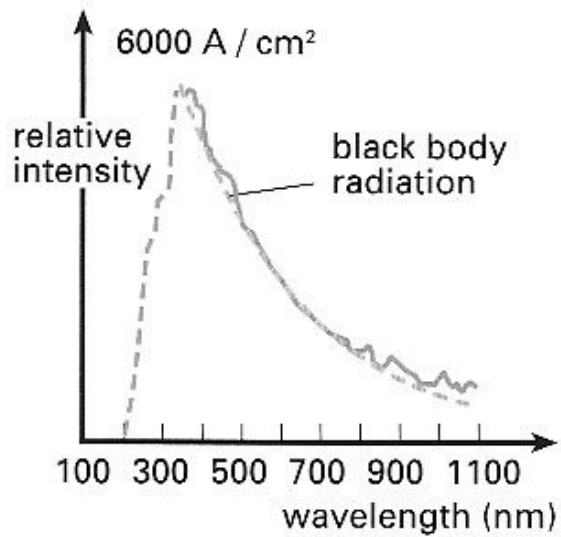

### Typical spectrum of a photo flashtube

The large portion of UV and blue in the spectrum of these tubes is interfering with photographic applications and is corrected by filters.

Short arc lamps which have very hot as well as very cold plasma zones due to missing wall stabilization can have both: IR lines and UV lines and a distinctive continuum.

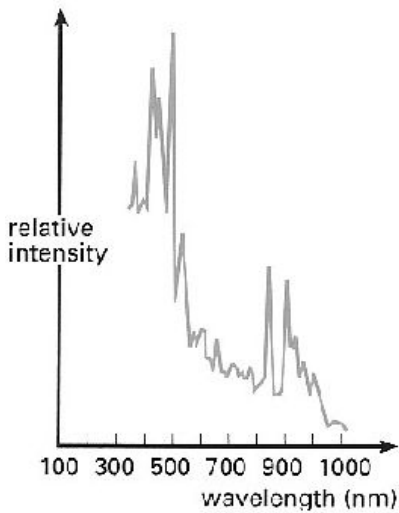

### Spectrum of a short arc flashtube

---

# Application Notes: Selection for Application

---

## Envelope materials

Flashtubes are divided into 2 groups, classified by power:

- Hard glass tubes.
- Quartz glass tubes (withstand 3 to 10 times more power than hard glass tubes).

### 1. Hard Glass

Selected four borosilicate glasses, characterized by their exceptional resistance to the arc and by their optical quality.

Borosilicate glass B1 (standard glass):

- Automatic processing ability.
- Many tube diameters available.

Borosilicate glass B2:

- Withstand approximately 30% more power than B1.
- Requires manual processing.

Borosilicate glass B3:

- Extra transparent for UV radiation.
- Automatic processing ability, similar to B1.

Borosilicate glass B4:

- Automatic processing ability.
- Allows up to double flash energy in photoflash applications compared to B1.
- Also used in high impedance tubes.

## 2. Quartz glass

Quartz glass gains its unique resistance to arc and thermal shock from the high bonding energy of pure SiO<sub>2</sub> and the negligible small expansion of  $4 \times 10^{-7}$  /K. Quartz glass usually requires manual processing.

Quartz glass Q1:

- UV transparent.

Quartz glass Q2:

- Reduced generation of ozone.

Quartz glass Q3:

- Spectral resistance to solarization.
- No generation of ozone.

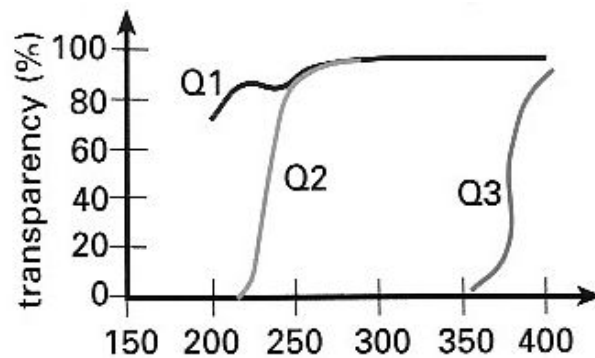

### Transparency of Quartz glass

Quartz glass Q1, Q2 and Q3 differs mainly in their UV transparency.

Synthetic quartz glasses are available on request.

## Color Corrective Coatings

Hard glass and quartz glass can be coated with a yellow layer absorbing the excessive blue radiation for film exposure. The color temperature is lowered by 1,000 to 2,000 K

## Life Expectancy

Flashtubes actually age by light output reduction. A decrease in triggerability is of minor importance. Statements on the life of a specific flashtube require exact knowledge of the following operating conditions:

- Flash energy
- Anode voltage
- Flash frequency
- Flash capacitor and its effective series resistance
- Resistances and inductances in the discharge circuit
- Reflector
- Cooling conditions
- Criteria defining the end of life

All details of the life expectancy mentioned in the catalog refer to nominal operating conditions, which are described in the individual specifications.